

Varenummer: 03551090

Beskrivelse: Fluro hydraulik ledhoved FPR 90CE

Mål

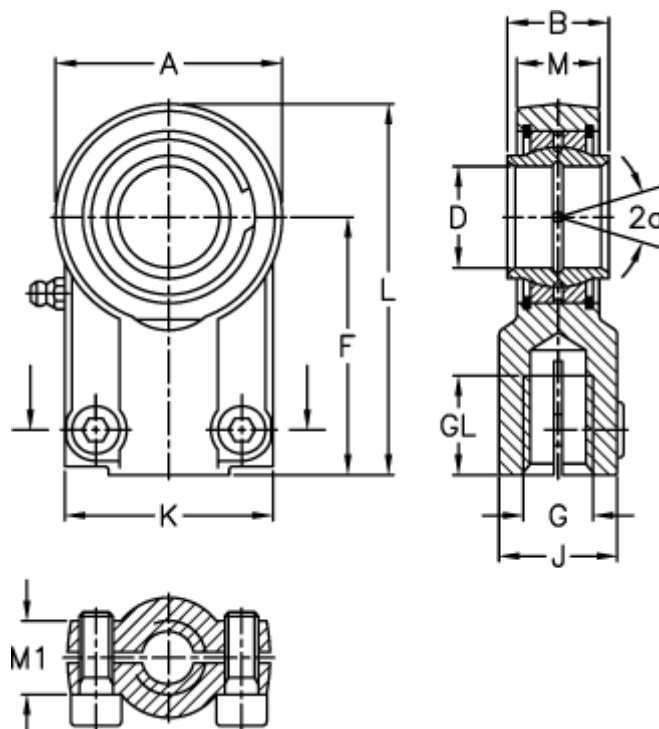

A	= 185	J	= 100
a (grader)	= 4	K	= 160
B	= 90	L	= 296
D	= 90	M	= 72
Dynamisk belastning C (kN)	= 490	M1	= 52
F	= 195	Moment (Nm)	= 410
g	= M72x3	Statisk belastning C0 (kN)	= 750
GL	= 91	Vægt	= 17500